

HOTA



S6 AC/DC Dual Channel Smart Charger Operating Instructions



ShenZhen HOTA Technology Co., LTD.



Thank you for using

S6 AC/DC Dual Channel Smart Charger

Thank you for purchasing the HOTA series of smart chargers. Please read this Instructions carefully before use so as to better make use of the product ; also keep this Instructions in a place safe for easy access.

If you want to know more about our smart chargers, please visit our website: www.hota-exp.com

Ver 1.0.1



C Contents

Product Overview	01
1、 Specifications	01
2、 Introduction	02
3、 Warnings and Safety Notes	03
4、 Recommended Way of Connection	03
5、 Balance port connection and Notes	04
6、 Mutli-Function port	05
7、 Standard battery types and task parameters	06
Operation and setup	07
1、 How to confirm the Charging Current	07
2、 Operative Skills	07
3、 Display of the working status	08
4、 Charger Settings	17
5、 Charger Settings >Task Parameters	18
6、 Charger Settings >System Parameters	19
8、 Task Settings	20
9、 Task Settings and Notes	21
Product Qualification Declaration	25
Troubleshooting	26
Warranty and Services	26
Safety Tips	27
Safety Notes	28

S6 AC/DC Dual Channel Smart Charger

Product features

- **Multiple outputs and high efficiency**

This is a dual channel AC/DC charging system that can handle different applications in various environments.

- **Combined charging ability, high performance**

S6 can concentrate output power of two channels on one battery, making the charge power in parallel up to 500W, parallel charging current up to 22A.

- **Globalization**

Fully support interface in Simplified Chinese, Traditional Chinese, Japanese, English and German, to ensure blockade-free usage.

- **Efficient heat dissipation**

This is a feature looks simple and easy-to-use yet with powerful technology works behind.

- **Dual channel output, each 325w 15A**

Highly optimized charging management algorithm, up to 94% operating efficiency, plus dual channel high power output, all added together gives people an image of superiority.

- **High security protection , things are simplified**

Advanced circuit design and software algorithms ensure that no matter under charging or discharging, this charger can easily deal with abnormalities such as overvoltage, overcurrent, overheat and short circuit.

- **Supports multiple types of batteries**

Perfect support for smart batteries and mainstream batteries; innovative charging algorithm for lithium battery makes charging of the lithium faster than others.

- **Rich mainstream interfaces that meet the application needs of all scenarios**

The charger is equipped with dual USB charging ports, plug and play, capable of meeting any needs of varied tasks. Furthermore, with excellent current output power at Type-C, it supports charging of laptops, tablets and other devices well, making users' jobs on travel trips much easier.

▶▶ Product Overview

Specifications

Input Voltage	AC 100~240V / DC 10.5~30V	Balance Current	1600mA x 2
Charge Power	DC 325W x 2 @ input voltage > 26V	Discharge Current	0.1~3A x 2
	AC 400W(support power distribution)	Combined Charge Power	500W
Charge Current	0.1~15A x 2	Combined Charge Current	0.1~22A
Discharge Power	Internal Discharge: 15W x 2 (Balance port 10Wx2)	USB-A Output	5V / 2.1A x 2
	External Discharge: 325W x 2 (650W)	Type-C Output	45W Max
Battery Type	LiHV/LiPo/LiFe/LiIon/LiIxx : 1~6S	Operating Temperature	0~40°C
	NiZn/NiCd/NiMH : 1~16S	Dimensions	116mm×116mm×85mm
	Smart Battery : 1~6S Lead Acid(Pb) : 1~12S(2~24V) Eneloop : 1~16S	Net weight	800g approximate
Protection Function	Temperature protection, Time Protection, Capacity protection, Input reverse protection, Output reverse protection, Short circuit protection, Output overcurrent protection, Output overvoltage protection, overcharge protection, over discharge protection .		

Product Overview

An introduction

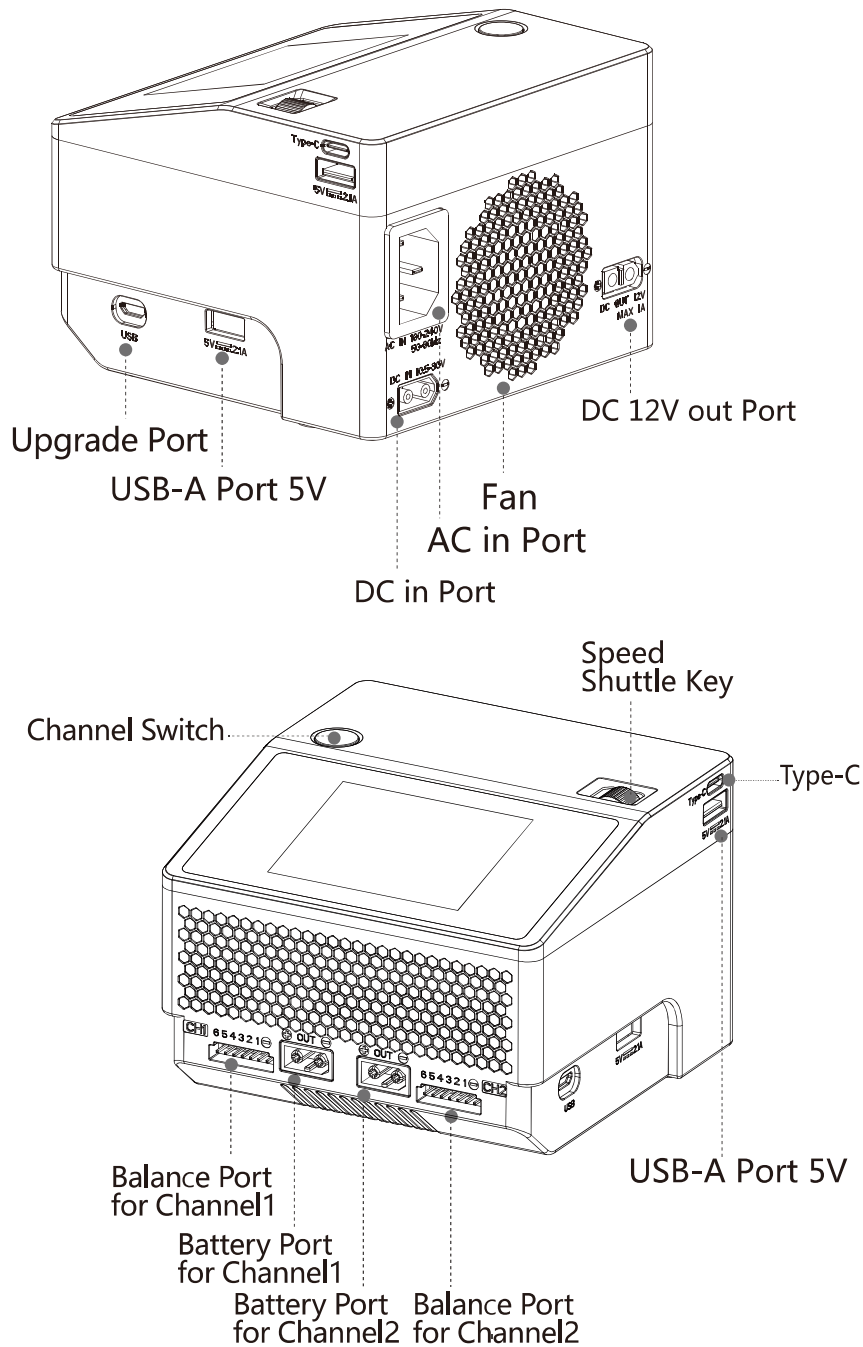

▶▶ Product Overview

Warnings and Safety Notes

1. Do not use the charger in an unattended manner, in case of any functional abnormality, please stop using it and refer to the manual.
2. Keep the charger away from dust, humidity, rain and high temperature, as well as direct exposure to sunlight and intense vibration.
3. Input voltage of the charger is 10.5-30V DC. When connecting to the power supply, make sure that the input voltage match the operating voltage range of the charger.
4. Please place the charger on a heat-resisting, non-flammable and insulating surface. Do not use it by placing it on the car's seat, carpet or other similar place. Keep inflammable and explosive objects away from operation areas of the charger.
5. Make sure the heat dissipation hole at the bottom of the charger is not covered while in use, and ensure the cooling fan smoothly extracts heat.
6. Please fully understand the charging and discharge characteristics as well as the battery 's specifications. Additionally, set up proper charging parameters in the charger. Incorrect setting of parameters can cause damage to the charger and battery ,even give rise to disastrous consequences such as fire and explosion.
7. When charging or discharging is completed, please first press the speed shuttle key to terminate the current task, then remove the battery when the charger shows the standby screen.



Recommended way of connection

- 1、 Connect power supply to the charger, wait for the system to complete its self-checking ;
- 2、 Choose the channel that is linked with the battery ;
- 3、 Through scrolling the Speed Shuttle key and the screen to set the task parameters suitable for the battery ;
- 4、 Enjoy.

▶▶ Product Overview

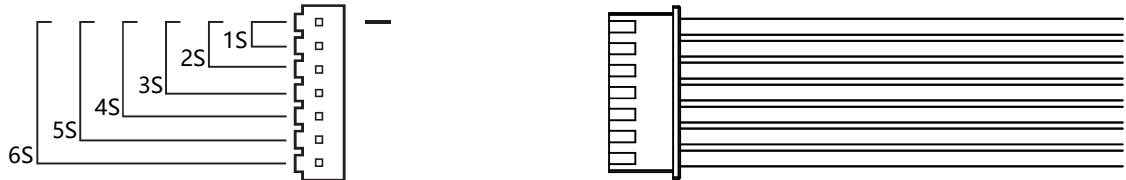

Balance Port Connection and Notes

1. The detection balance port of this product is suitable for lithium battery packs;
2. When the battery is connected, it is aligned with the " - " sign . The diagram above shows the alignment of the balance plug;

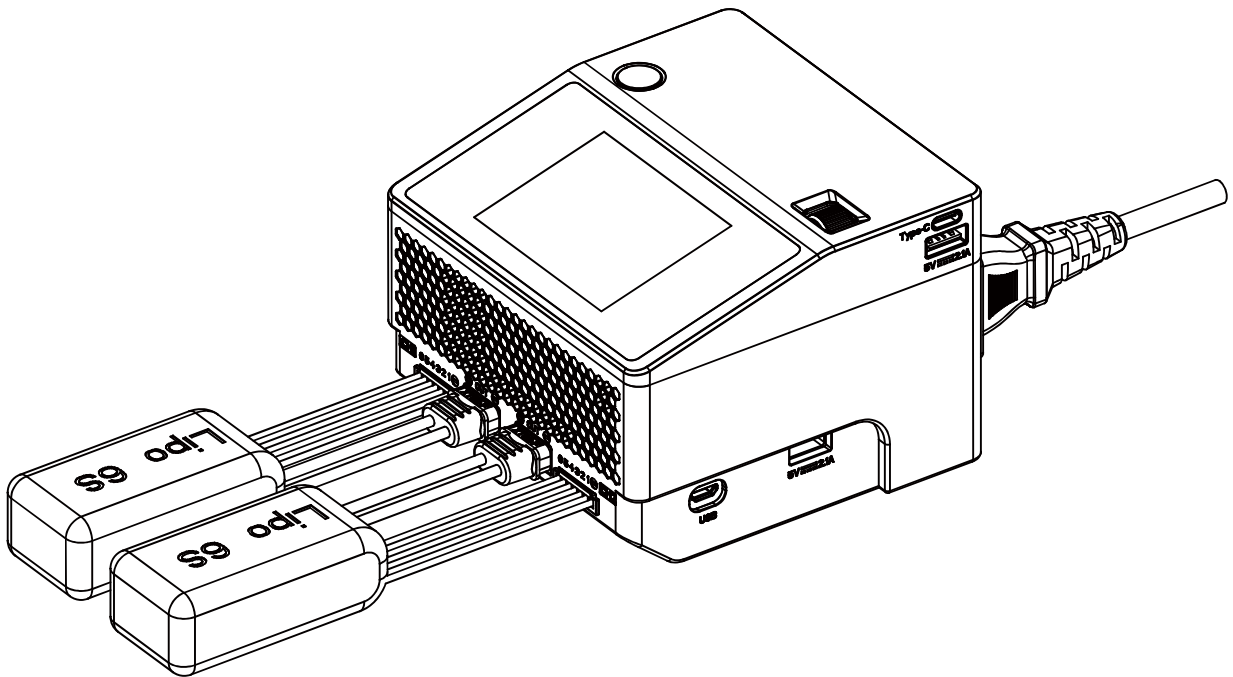

▶▶ Product Overview

Separate output ports of 2A1C and XT60-F

1.1.Connect to FPV Display

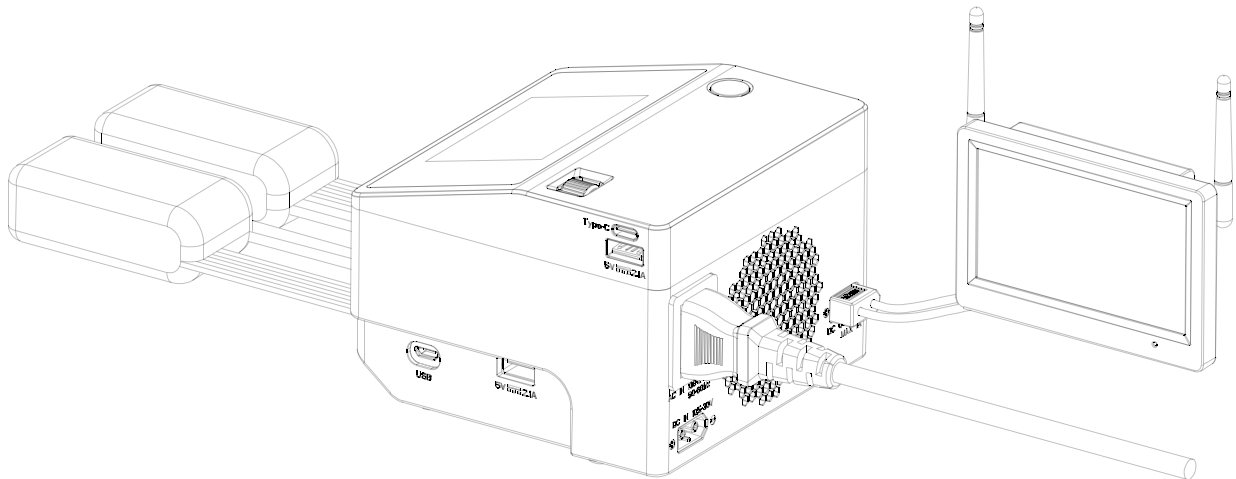

2.The charger gets two USB-A ports and one Type-C port, together with the independent output power of 2A1C and XT60-F outputs , it can meet needs of different applications under many scenarios .



▶▶ Product Overview

Standard Battery Types and Task Parameters

Battery Type / Task Parameters	NiCd NiMH	LiFe	Lilon	LiPo	LiHV	NiZn	Lixx	Smart Battery	Pb	Eneloop
Rated Voltage	1.20V	3.20V	3.6V	3.70V	3.80V	1.50V	3.7V	3.70V	2.00V	1.20V
Full Charge Voltage	1.50V	3.65V	4.10V	4.20V	4.35V	1.93V	4.20V	4.20V	2.46V	1.50V
Storage Voltage	No support	3.30V	3.70V	3.80V	3.85V	1.60V	3.80V	3.80V	No Support	No Support
Discharge Voltage	0.90V	2.90V	3.20V	3.30V	3.40V	1.20V	3.30V	3.30V	1.90V	0.90V
Balance Charge	No Support	Support	Support	Support	Support	Support	Support	Support	No Support	No Support
Unbalanced Charge	Support	Support	Support	Support	Support	Support	Support	Support	Support	Support
Support Cells	1-14S	1-6S	1-6S	1-6S	1-6S	1-14S	1-6S	1-6S	1-12S	1-14S
Max Charge Current	15.0A	15.0A	15.0A	15.0A	15.0A	15.0A	15.0A	15.0A	15.0A	15.0A
Max Charge C Value	≦2C	≦4C	≦1C	≦1C	≦1C	≦0.5C	≦1C	≦1C	≦0.5C	≦0.5C



Be very careful to choose the correct voltage for different types of batteries otherwise it may cause damages to them. Incorrect settings could cause the battery to burn or to explode, leading to injury of people or loss of property.

▶▶ Operation and Setup

How to conform the charging current

- It is important to know the maximum charging current of the battery before charging as excessive current could influence the life span of battery, even cause damages. In addition, excessive current can cause heating even explosion of the battery during the charging process.
- The charging and discharge capacity of battery is usually marked with C value. Multiplying the charging C value and battery capacity equals to the maximum charging current supported by the battery. For example, for a 1000 mAh battery with a charging capacity of 5C, its maximum charging current would be $1000 * 5 = 5000\text{mA}$; that is, the maximum charging current is 5A.
- For a lithium battery, if it is impossible to confirm the supported charging C value, please set the charging current below 1C for the sake of its (lithium battery) safety.
- The reference relation between C value and charging time: charging time ≥ 60 minutes/ charging C value (it therefore needs around 60~70 minutes to complete charging with 1C). Due to the differences in battery power conversion efficiency, this period of time to complete the charging may be extended.

Operative Skills

1. Connect power supply to the charger and wait for the system to complete its self-checking. In standby interface, connect well the battery to the charger. Short press the Channel switch key to choose whatever channel prefers. After having chosen the channel, short press the speed shuttle key to pop up the "Task Settings" menu;

2. When a task is being executed, short press the speed shuttle key to pop up the "Adjust Task" menu to adjust the task's current;

3. Long press the Channel switch key can end the task of current channel quickly or enter the "Task Settings" menu of the channel.

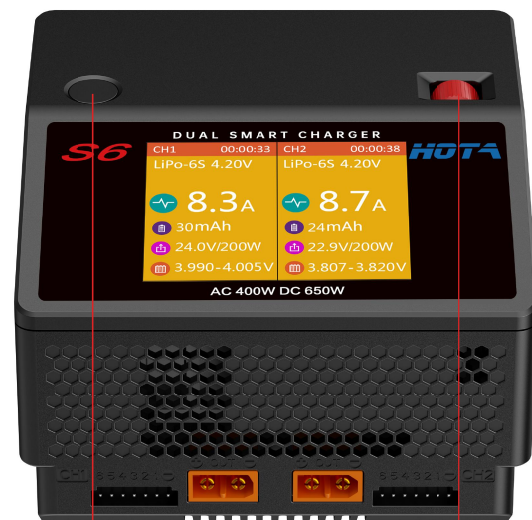

Channel Key

Speed shuttle key

▶▶ Operation and Setup

Working parameters Display

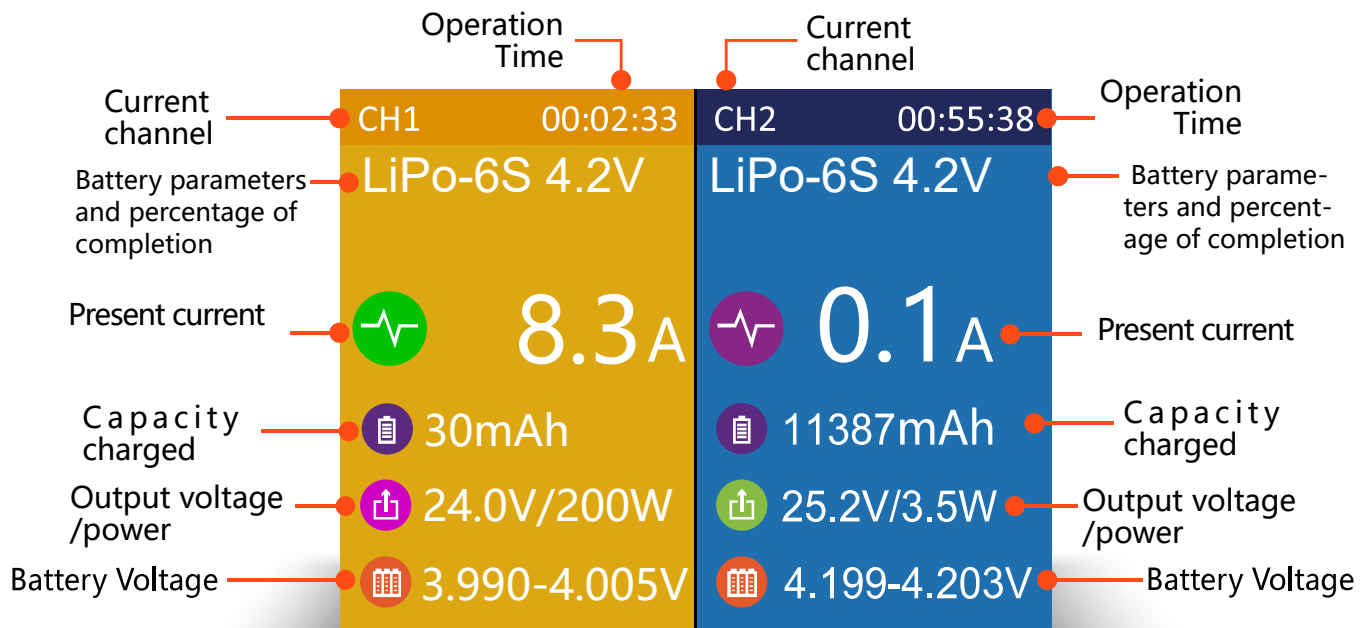

Split Screen Display

■ CH1: Charging

■ CH2: Charging completed

Split-Screen Display : Simple Operation

1. Boot into the Split-screen display ----- Standby state;
2. In the standby state, long press the speed shuttle key to enter "Charger Settings" ;
3. Short press CH key to display the channel you choose;
4. Long press the CH key to stop the current task of double channels .

▶▶ Operation and Setup

Working parameters Display

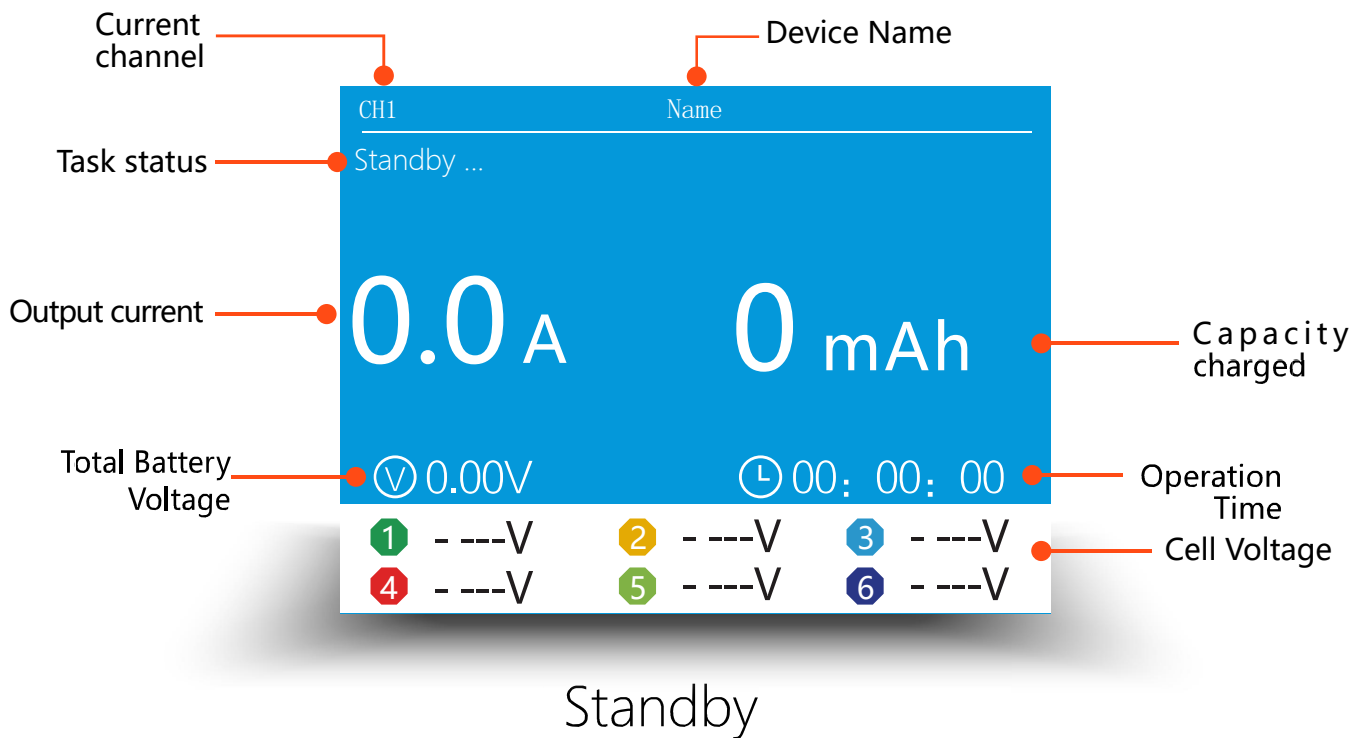

Standby State : Simple Operation

1. Connect power supply to the charger, wait for the system to complete its self-checking. Connect the battery to the charger in the standby interface;

2. In the standby state, the screen is in blue color. At that time, the output current, total battery voltage, capacity completed and operation time are all shown as zero.

Scroll the speed shuttle key can switch the display information in the lower half of the screen, which are cell voltage and the operating data.

3. After selecting the corresponding channel, short press the speed shuttle key can pop up the "Task Settings" menu.

4. Short press CH key can switch the channel;

5. Long press the speed shuttle key to enter the "Charger Settings" menu.

▶▶ Operation and Setup

Working parameters Display

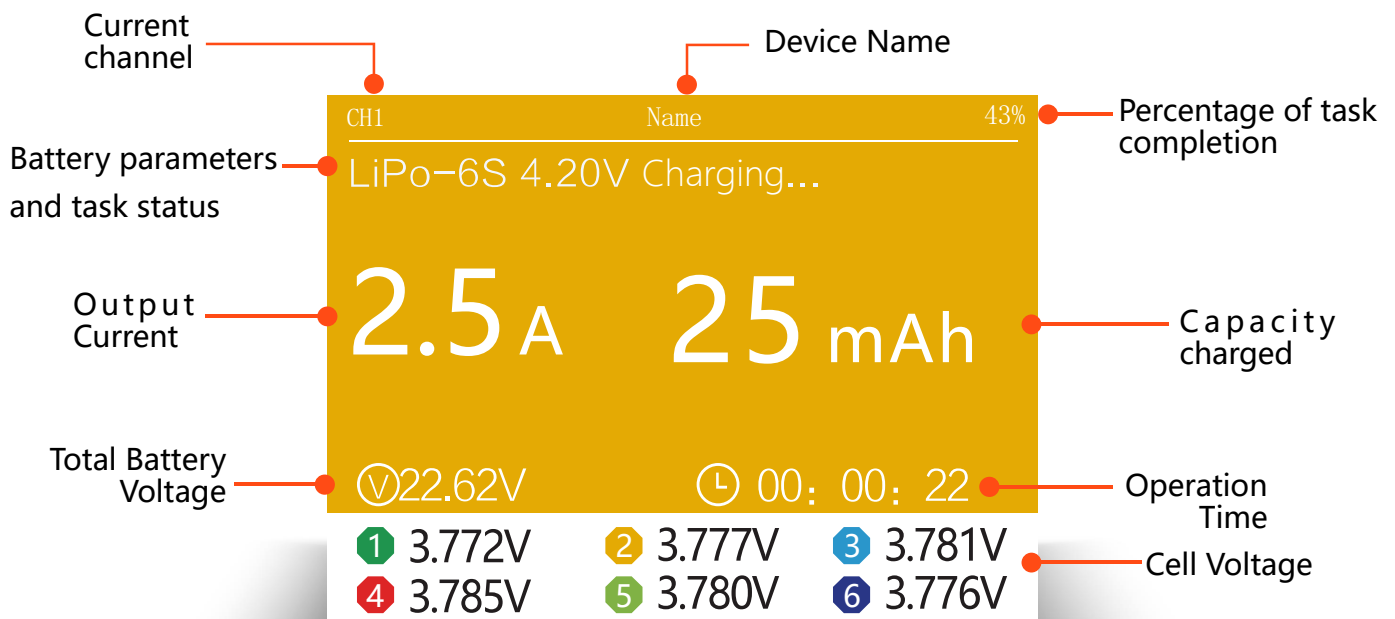

Charging

Charging Status : Simple Operation

1. Connect power supply to the charger, wait for the system to complete its self-checking. Connect the battery to the charger in the standby interface;
2. After selecting the corresponding channel, short press the speed shuttle key to pop up the "Task Settings" menu, set the task to "Charge" ; adjust the task parameters, and short press the speed shuttle key to start the task;
Scroll the speed shuttle key can switch the display information in the lower half of the screen, which are cell voltage, cell internal resistance and the operating data. Cell voltage can only be displayed in the mode of balance charging and the internal resistance can only be displayed while measurement is valid (not in precharged status and none of the cells reaches fully charged status within 2 minutes);
3. When the charge task is executing, short press the speed shuttle key can pop up the "Adjust Task" menu to adjust the charge current ; long press the CH key can stop the current task ;
4. Enjoy.

▶▶ Operation and Setup

Working parameters Display

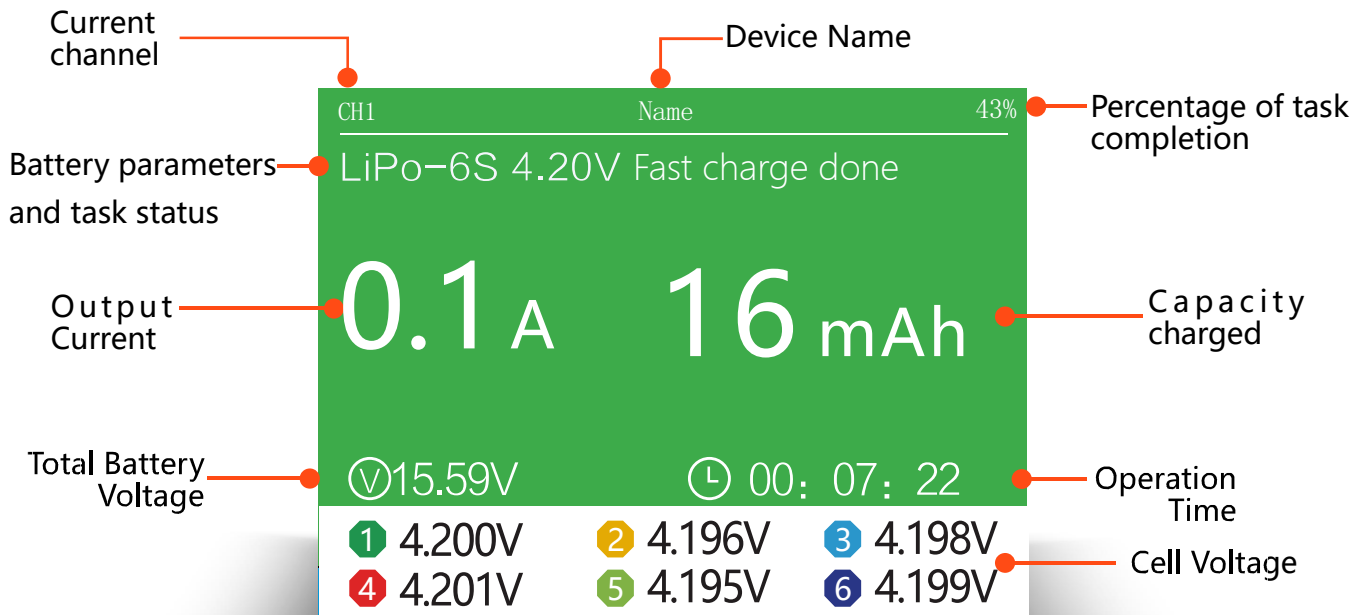

Fast Charge done

Fast Charging Completed Status : Simple Operation

1. When fast charging is completed, the cell voltage difference is less than 20mV ,show ing fast charging completed ;
(At that time, press the speed shuttle key to stop the task before removing the battery)
2. Long press the CH key can stop the current task;
3. Short press the CH key can switch the channel .

▶▶ Operation and Setup

Working parameters Display

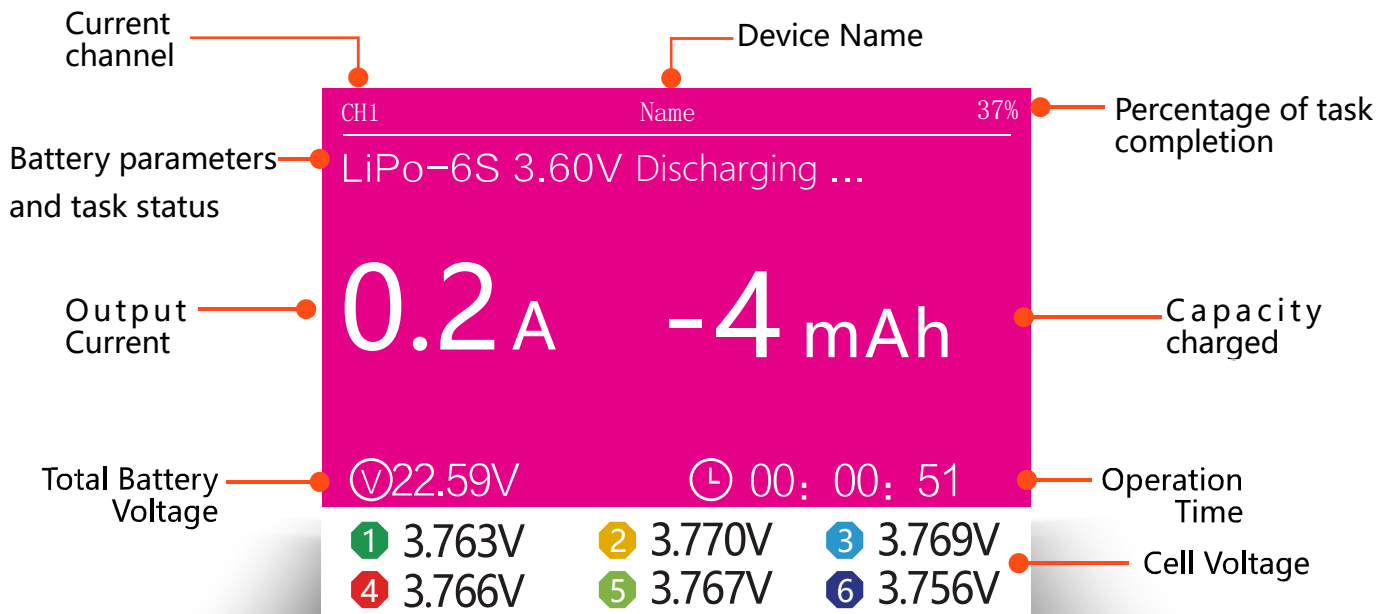

Discharging

Discharging Status : Simple Operation

1. Connect power supply to the charger, wait for the system to complete its self-checking. Connect the battery to the charger in the standby interface;
2. After selecting the corresponding channel, short press the speed shuttle key to pop up the "Task Settings" menu, set the task to "Discharge"; adjust the task parameters and short press the speed shuttle key to start the task;
Scroll the speed shuttle key during operation can switch the display information in the lower half of the screen which are cell voltage and operating data; the cell voltage can only be displayed in the mode of balance charging;
3. When the discharge task is executing, short press the speed shuttle key can pop up the "Adjust Task" menu to adjust the discharge current; long press the CH key can stop the current task;
4. Enjoy.

▶▶ Operation and Setup

Working parameters Display

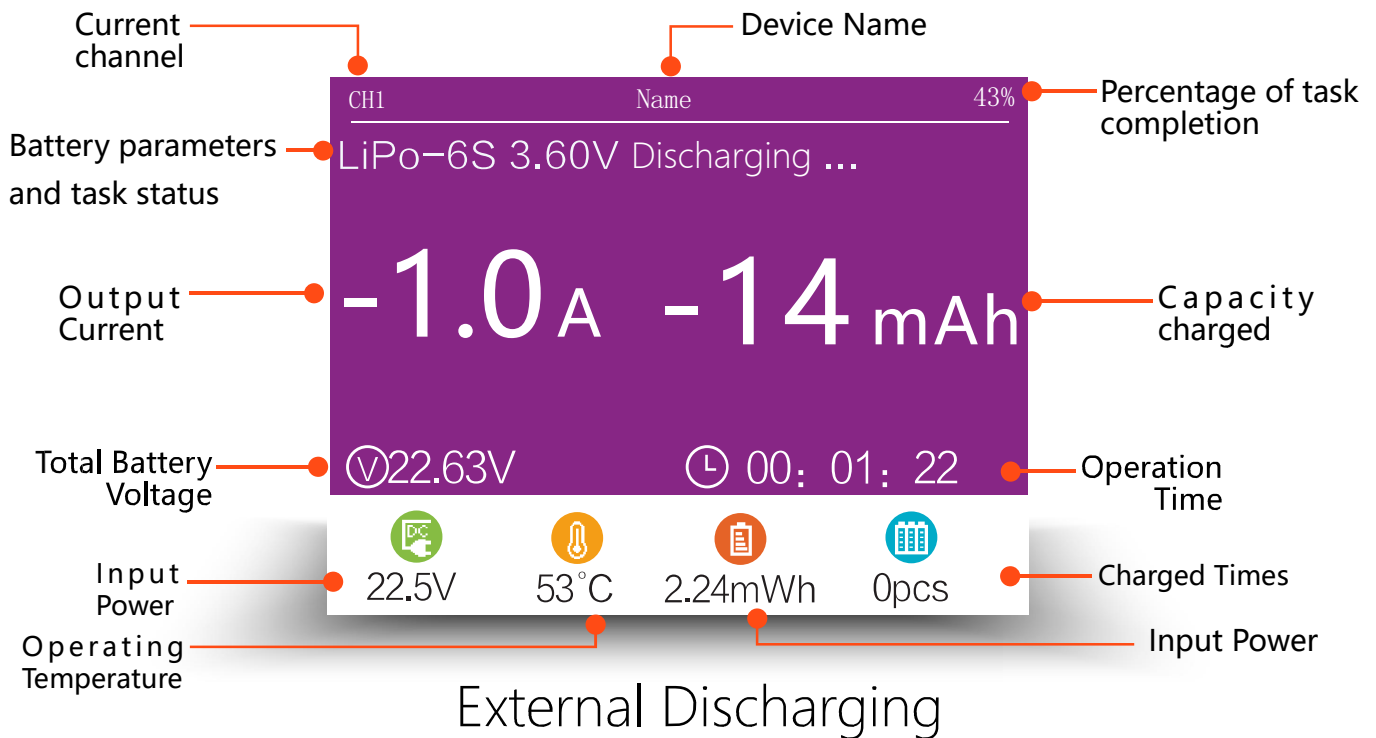

External Discharging status : Simple Operation

1. Connect the battery, which is going to discharge ,to the input ends(DC port) of the charger, and wait for the system to complete its self—checking, then in the standby interface, connect the high power resistance load to the charger's output ends ;
2. After selecting the corresponding channel, short press the speed shuttle key to pop up the "Task Settings" menu, set the task to "External Discharge" ; adjust the task parameters and short press the speed shuttle key to start the task;
3. When the External discharge task is executing, short press the speed shuttle key can pop up the "Adjust Task" menu to adjust the external discharge current ; long press the CH key can stop the current task;
4. Enjoy.

▶▶ Operation and Setup

Working parameters Display

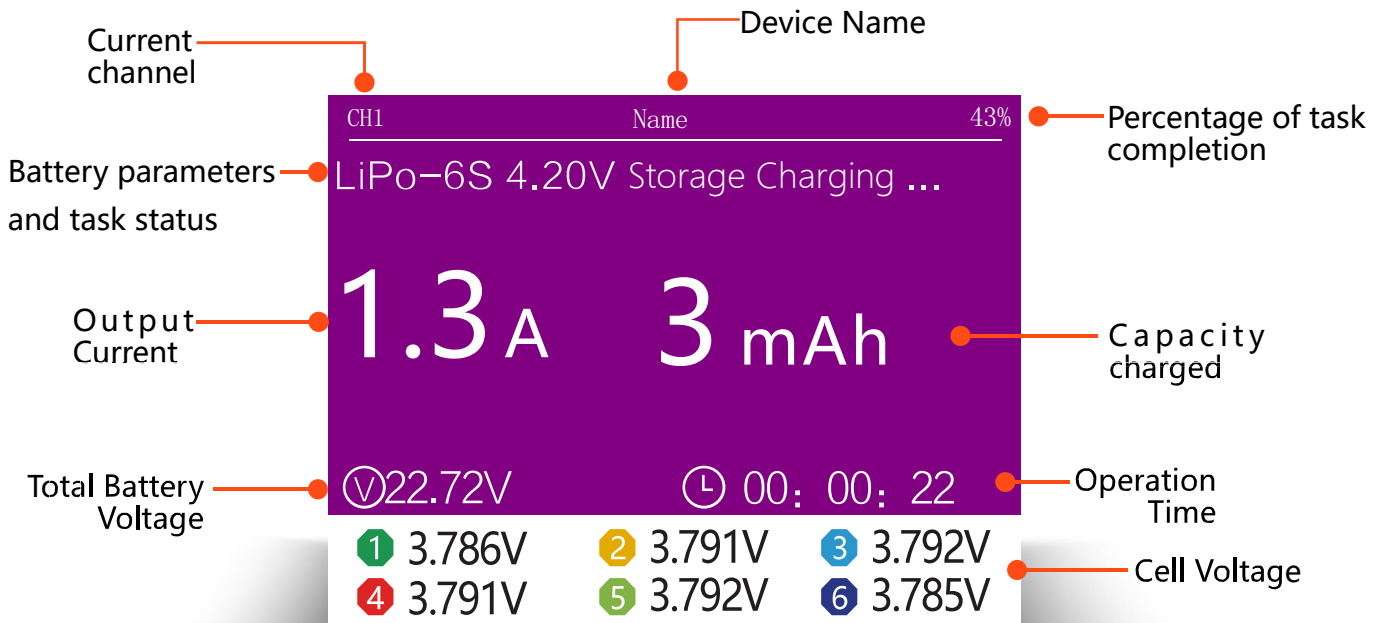

Storage Charging

Storage Charging Status : Simple Operation

1. Connect power supply to the charger, wait for the system to complete its self-checking. Connect the battery to the charger in the standby interface;
2. After selecting the corresponding channel, short press the speed shuttle key to pop up the "Task Settings" menu, set the task to "Storage" ; adjust the task parameters, and short press the speed shuttle key to start the task;
Scroll the speed shuttle key during operation can switch the display information in the lower half of the screen, which are cell voltage and the operating data ; the cell voltage only be displayed in the mode of balance charging.
3. When the storage task is executing, short press the speed shuttle key can pop up the "Adjust Task" menu to adjust the storage current ; long press the CH key can stop the current task;
4. Enjoy.

▶▶ Operation and Setup

Working parameters Display

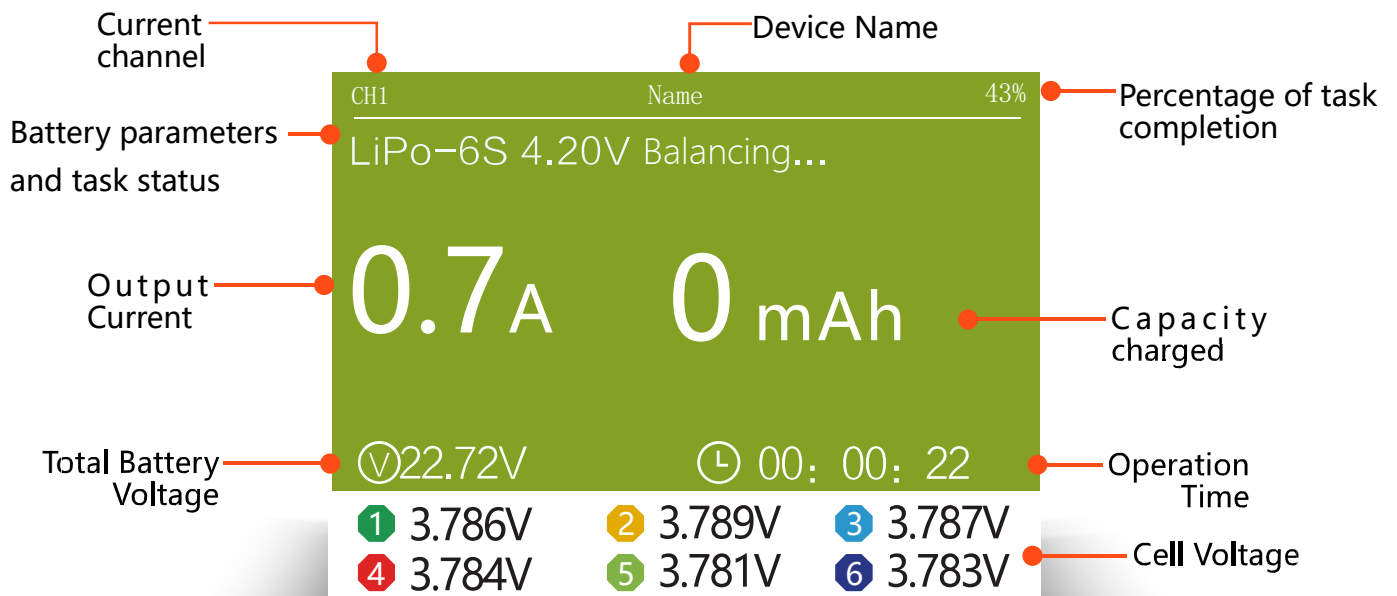

Balancing

Balancing Status : Simple Operation

1. Connect power supply to the charger, wait for the system to complete its self-checking. Connect the battery to the charger in the standby interface;
2. After selecting the corresponding channel, short press the speed shuttle key to pop up the "Task Settings" menu, set the task to "Balance" ; adjust the task parameters, and short press the speed shuttle key to start the task;
Scroll the speed shuttle key during operation can switch the display information in the lower half of the screen which are cell voltage and the operating data;
3. When the balance task is executing, short press the speed shuttle key can pop up the "Adjust Task" menu to adjust the balance current ; long press the CH key can stop the current task;
4. Enjoy.

▶▶ Operation and Setup

Working parameters Display

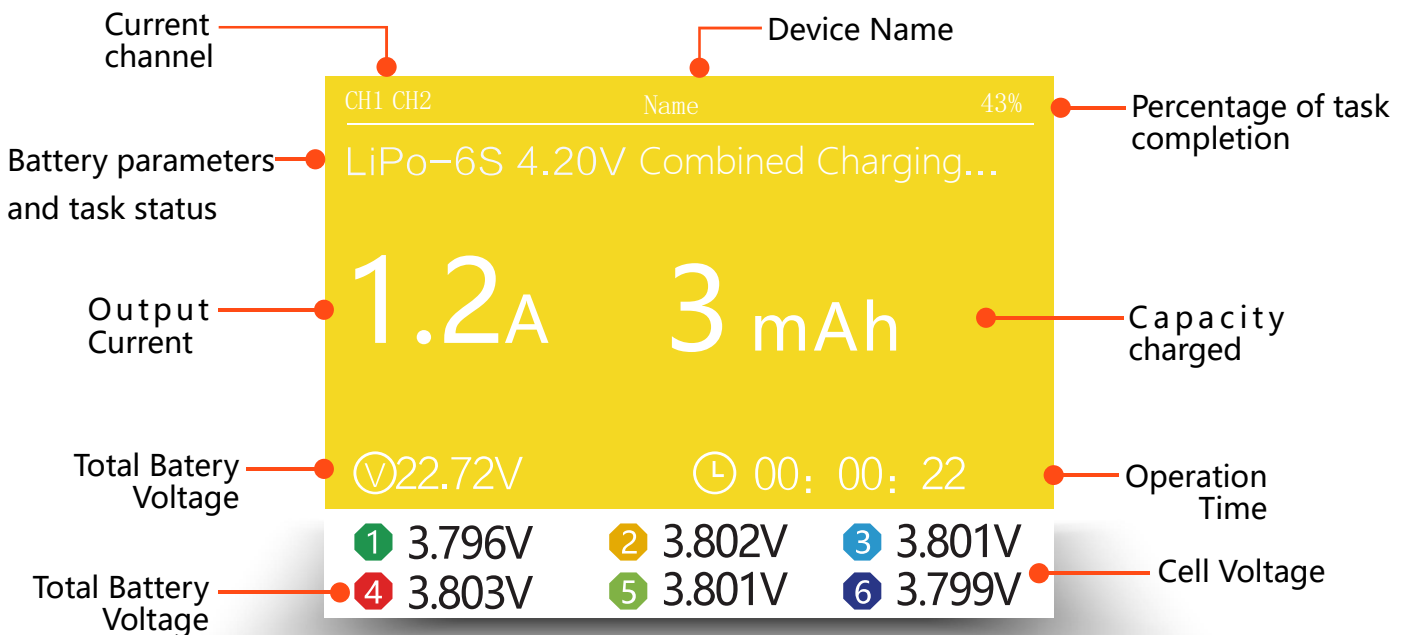

Combined Charging

Combined Charging status: Simple Operation

1. Connect power supply to the charger and wait for the system to complete its self-checking .Connect the battery to the two output ports of the charger in the standby interface ;

2. After selecting corresponding channel , short press the speed shuttle key to pop up the "Task Settings" menu, set the task to "Combined Charging" ; adjust the task parameters, then short press the speed shuttle key to start the task ;

Scroll the speed shuttle key during operation can switch the display information in the lower half of the screen, which are cell voltage , cell internal resistance and the operating data. The cell voltage can only be displayed in the mode of balance charging ; cell internal resistance will only be displayed in the balance mode while measurement is valid (not in precharged status and none of the cells reaches fully charged status within 2 minutes).

3. When the task of charging is executing, short press the speed shuttle key can pop up the "Adjust Task" menu to adjust the charging current ; long press the CH key can stop the current task.

4. Enjoy.

▶▶ Operation and Setup

Charger Settings

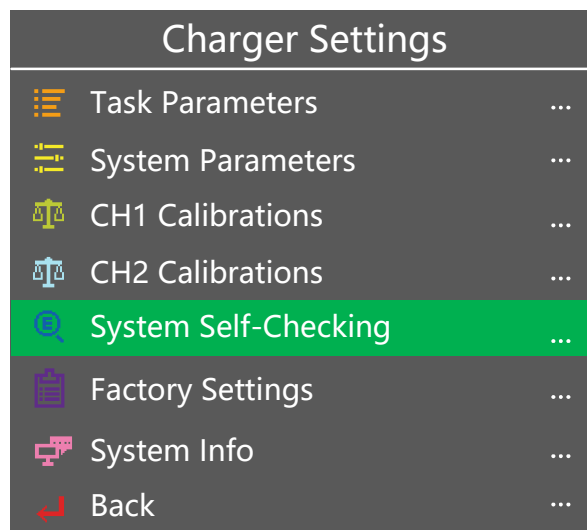

In the alternate interface, long press the speed shuttle key to bring up the "charger settings" menu, the menu items are as follows:

Task Parameters	Adjust Safety Timer, Max Capacity, End Current and other parameters
System Parameters	Adjust Language, LCD backlight, Input Power, Input Voltage, Volume and other parameters, Night mode
CH1 Calibrations	Used for channel 1 data calibration
CH2 Calibrations	Used for channel 2 data calibration
System Self-checking	Start self—checking of the charger
Factory Settings	Restore all parameters to factory settings (User calibration data clean up)
System Info	Display system information, serial number
Back	Exit charger settings

▶▶ Operation and Setup

Charger Settings > Task Parameters

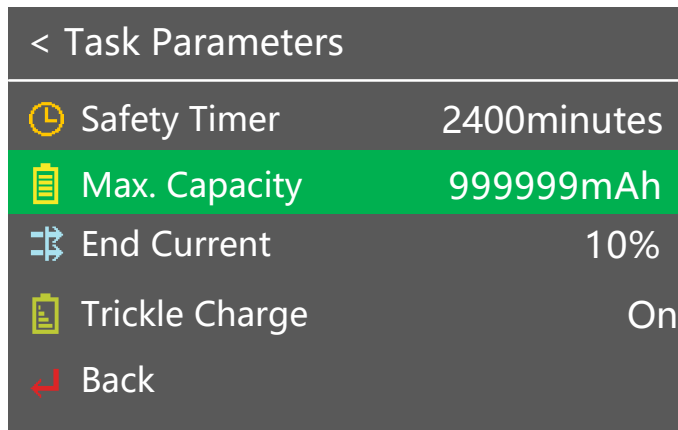

< Task Parameters	
🕒 Safety Timer	2400minutes
📄 Max. Capacity	999999mAh
⚡ End Current	10%
📄 Trickle Charge	On
↩ Back	

In the standby interface, Long press the speed shuttle key to pop up the “Charger Settings” Menu , then choose “Task parameters” ; the menu items are as follows:

Safety Timer	Allow maximum running time; running beyond this setting, automatic protection will stop the task.
Max.Capacity	Allow maximum charging capacity; running beyond this setting, automatic protection will stop the task.
End Current	Cut off when the current is less than the ratio between task completed current and set up current
Trickle Charge	Whether to turn on trickle charge: On or Off
Back	Exit to the upper menu

▶▶ Operation and Setup

Charger Settings > System Parameters

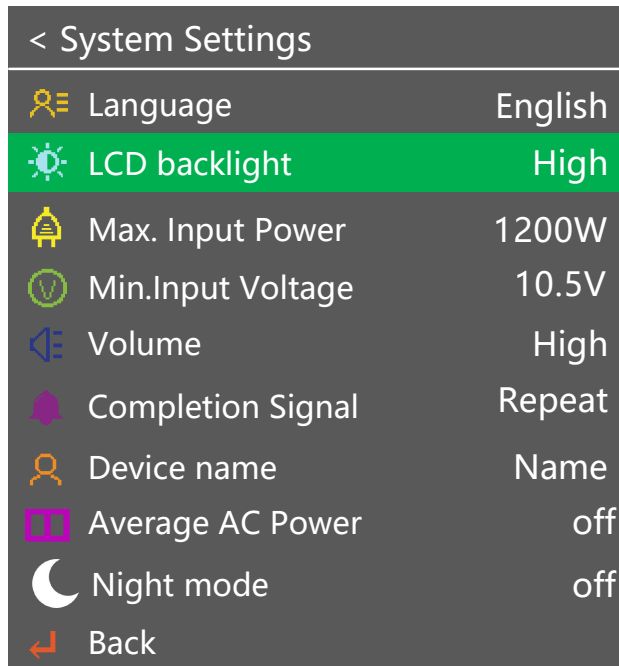







In the standby interface, long press the speed shuttle key to pop up the "Charger Settings" menu, then choose "System parameters"; menu items are as follows:

Language	System language setting
Regenerative Discharge	Set current, voltage and power
Max.Input Power	Input power limit setting
Min.Input Voltage	Input voltage limit setting
LCD backlight	Backlight adjustment: high, middle, low
Volume	Buzzer volume adjustment: high, middle, low
Completion Signal	Single or Repeat
Device Name	Press the speed shuttle key to enter ; need to manually enter the name of the device, long press the speed shuttle key to exit
Average AC power on Channel	Whether open the average AC power : On or off
Night Mode	Whether open the night mode : On or off
Back	Exit to the upper menu

Buzzer volume: if set as OFF, the operation sound will be blocked, but not the sound of error warning

▶▶ Operation and Setup

Task Settings

Task Settings	
 Select Task	Charging
 Battery Type	LiPo
 Cell Voltage	4.20V
 Cell Count	6S(22.2V)
 Current Settings	1.0A
 Start Task	
 Back	

Connect power supply to the charger, wait for the system to complete its Self-checking. In standby interface , connect the battery to the charger , then after selecting the corresponding channel , short press the speed shuttle key to pop up the "Task Setting" menu .

Select Task	Select task options: Power supply , charging , discharge, external discharge, storage, balance,combined charging
Battery Type	Select battery types: Smart battery, LiHV, LiPo, Lilon, LiFe, LiXX, NiZn, Pb, NiCd, NiMH, Eneloop
Cell Voltage	Fine-tuning the End-voltage
Cell Count	Select battery's strings: 1~6S ; if balance port is inserted, it is automatically tested, no need to do any settings
Current Setting	Select current, charging/storage 0.1~ 15.0A, discharge 0.1 ~ 3.0A , external discharge 1.0~ 15.0 A
Start Task	Start to execute task
Back	Back

▶▶ Operation and Setup

Task Settings and Notes

The S6 smart charger operates in a series charging mode. When connecting to the battery, the battery output cable must be connected. For lithium batteries, it is strongly recommended to connect the balance ports for balanced charging so as to ensure that the charger can accurately monitor the voltage of each cell and balance the cells having poor consistency. When charging in unbalanced mode (without connecting to the battery balance port), the charger will have a warning before starting the task.

Power supply Function

When the power function is selected, the entire charger is equivalent to an adjustable power supply, the voltage of the output port and the output power can be set. The output port voltage can be set between 5V~24V, and the output power can be set between 100W ~ 300W. The output port wires must not be stuck together to avoid causing any short circuit and cannot be overloaded so that it burns the machine.

Charge Function

When charging is in progress, the screen is marked in orange; the screen turns green or blue when charging is completed. When the charging is completed, the cell voltage difference is less than 20mV, and the screen turns green. If user needs to use it urgently, he can stop charging it. If charging is not stopped at that time, the charger will continue to balance the battery. When the voltage difference is less than 10mV, the screen will turn blue. After it turned blue, the charger will still continue to accurately balance the battery.

After having the battery charged, the voltage will drop back due to the difference in performance and it is normal. As the number of charging increases, the performance of the battery gradually declines, such a phenomenon will become obvious. Charging with a larger charging current will also cause the voltage to fall back after a full charge, which is more obvious.

Tips: If you are charging batteries outdoors, and you want to finish it quickly, you can stop charging when you see the appearance of green state. When there is enough time, and you hope that the battery can achieve a better balance, then wait for the blue color to appear, or wait for a while more after the blue appear to get more accurate effect.

Discharge Function

The discharge function can discharge the battery. It is recommended to connect the balance port for discharge, which is faster and the detection of the end of discharge more accurate. Due to the limitation of the internal discharge power, the discharge process may be slower, which is normal.

▶▶ Operation and Setup

Task Settings and Notes

External Discharge Functions

The external discharge function uses an external high-power load resistor to quickly discharge the battery in an accurate way. When using it, the battery to be discharged needs to be connected to the input port, and the output is connected to the resistor load. It is recommended that the resistance of the load be between 1.5 and 2.5 ohms. Other resistance values can also be used normally, but may not be able to operate at full power. While the external discharge is running, the load is very hot, please pay attention to safety and avoid accidents or personal injury.

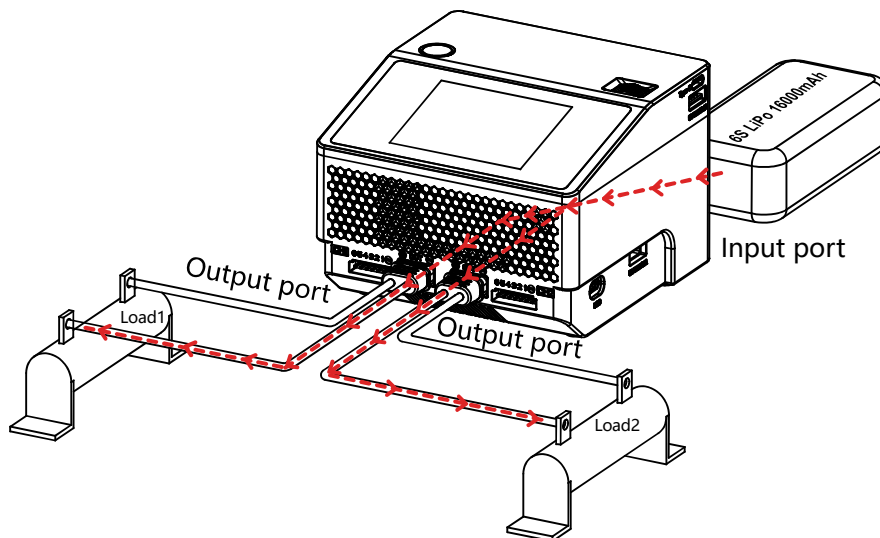

Storage Function

When the storage function is selected and if the battery is lower than the preset storage voltage, the charging task will be automatically performed; if the battery voltage is higher than the preset storage voltage, the discharge task will be automatically performed. In order to save the task time, the storage and discharge tasks do not accurately balance the cell voltage. There may have some error between the cell voltage and the preset value at the end of the task, which is a normal phenomenon.

Balance Function

The balance function is used to balance the voltage of batteries and make them equal. The balance time is related to the battery voltage difference and the target voltage. When the menu is switched to the balance mode, the charger automatically analyzes and sets the initial balance voltage value, and the user can freely adjust it. The charger's charging ability is much larger than the discharge capacity; in the balance operation, selecting voltage equal or larger than the current battery voltage usually lets user attain faster effect in balancing.

▶▶ Operation and Setup

Task Settings and Notes

Battery Activation and Repair

After the charging task starts, if it is detected that the cell voltage be lower than the pre-charging voltage, the cell will be activated and repaired using one tenth of the task setting current. After the voltage becomes higher than the pre-charging voltage, the voltage will be adjusted to the set voltage for charging. Such design can protect the over—discharged battery , activate and repair it.

About Internal Resistance Measurement

The S6 Smart Charger has a cell internal resistance measurement function that is only effective when performing balanced charging tasks on the battery. About two or three minutes after the start of the charging task, the internal resistance of the cell is measured and calculated. The internal resistance of the battery varies with different power levels. Generally speaking, the internal resistance measured is lower when the power is higher.

When the charger measures the internal resistance of the battery, the charging current is instantaneously adjusted. Therefore, it is normal to find that the current is abruptly changed during the charging process.

Due to the differences in the ways of measuring the internal resistance ,it is not possible to reach the test accuracy of internal resistance like those attained on professional measuring instruments . Therefore, the internal resistance value is only suitable for horizontal comparison reference, such as judging the consistency of cell performance or comparing the performance parameters of different batteries. The magnitude of the charging current has certain influence on the accuracy of measuring the internal resistance. A battery with a large capacity and low internal resistance requires a larger charging current to accurately measure its internal resistance.

▶▶ Operation and Setup

Task Settings and Notes

Combined charging Function

When the combined charging is in progress, the screen is marked in orange. After the combined charging is completed, the screen will change to green or blue. When the combined charging is completed and the battery cell voltage difference is less than 20mV, the screen will change to green. If in urgent usage, the charging can be stopped at that moment. If you don't stop it at that time, the charger will continue to balance the battery until the voltage difference becomes less than 10mV, then the screen will turn blue. After it turned blue, the charger will continue to accurately balance the battery.

After the battery is charged, the voltage will drop to a certain extent due to the difference in performance, which is a normal phenomenon. And as the battery recharges more and more, the performance of it gradually decreases, this phenomenon of voltage drop will become more and more obvious. Using larger charging current for charging will also lead to more significant voltage drop after a fully charge.

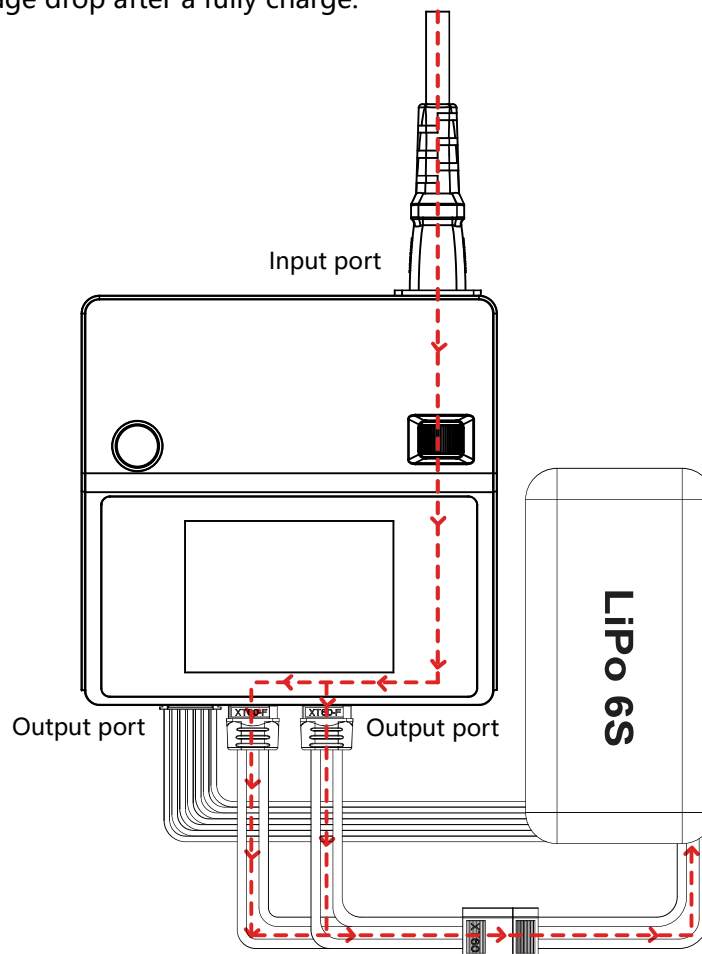

▶▶ Product Qualification Declaration

- S6 Smart Charger confirms to the relevant commands in Chapter 15B :2017 of the FCC

Testing Standards	Result
EN 60950-1:2006+A11:2009+A1:2010+A12:2011+A2:2013	yes
EN 62311:2008	yes
ETSI EN 301 489-1 V2.2.0(2017-03) ETSI EN 301 489-3 V2.1.1(2017-03)	yes
ETSI EN 303 417 V1.1.1(2017-09)	yes

▶▶ Troubleshooting

- Error handling during “System self—checking ” : when the charger is performing the System self—checking and if the output port is connected to the battery, it will cause a self-checking error ; at that time, the battery should be removed and wait for 5 seconds before retest. Do not insert or detach battery from the DC port during the System self-checking. Wait for the self—checking to complete before performing any other operations.
- Battery connection error handling: Re-plug the battery and ensure that all connections are in secure contact. If the error messages repeatedly appear, check the battery connection metal parts for oxidation or burning that may affect the contact status.

▶▶ Warranty and Service

- We provide one-year warranty for this charger from the date of purchase. Within one year, our company will repair the product for you free of charge. We will not provide free repair service if it is caused by improper use or modification of the customer. If there is a problem with your product and it is covered by the warranty, please contact us immediately , we will assist you with the relevant maintenance.
- If it is necessary to replace parts out of the warranty time, we will charge you some-component fee and maintenance fee.During the warranty period, repairs are not free of charge if:
 - 1) Failure or damage caused by improper use or disassembly, attachment or modification as specified in the Instructions.
 - 2) Failure or damage caused by natural disasters, falls, collisions, and improper voltage.

▶▶ Safety Tips

Do not charge/store the following types of batteries:

- Batteries of different manufacturers, different models, different types or different capacity
- Non-rechargeable battery (may cause an explosion)
- Battery of unrecognized type or unknown parameters
- Battery with special requirements for charging technology
- Battery that is damaged or defective
- Battery with built-in combined circuit or protection circuit
- Battery installed in another device or connected to other components
- Rechargeable battery suitable for carrying current of this charger yet without confirmation from the manufacturer



The electronic products with this mark in the Instructions must be disposed of separately from household waste when handling scrapped products.

Take it to the garbage collection center for classification.

Statement

- The S6 Smart Charger is designed for the battery types listed in this Instructions. The company does not bear any responsibility if the user uses the charger for purposes other than those listed in the Instructions. We can not be sure if you ever read the instructions carefully before using them, nor can we control how you use and store the product.

All specifications and parameters are subject to change without prior notice!

Copyright © 2022 Shenzhen HOTA Technology Co., Ltd. All rights reserved

The products described in this Instructions, including software, product features, appearance, UI design, etc., have property rights protection, any individuals or organizations must not copy or plagiarize. Once discovered, HOTA will pursue its legal rights.

▶▶ Safety Notes

Before using the charger for the first time, please read the details in the "Safety Notes ". Make sure you use this charger safely and correctly.



WARNING!



FIRE HAZARD!

NEVER USE CHARGER UNSUPERVISED!

- Please read the complete Instructions carefully before using the charger;
- Make sure that the charger is kept away from heat and humid environment during use, pay attention to ventilation and heat dissipation, pit it away from flammable materials;
- Do not let the child operate the charger. Do not let the charger work not under your attention;
- Correctly set the battery charging and discharging parameters, wrong settings may lead to accidents;
- Failure to follow safety procedures may result in property damage or personal injury;
- If the operation is not proper, the charger and battery will have a serious fire risk;
- After use, disconnect the input power and remove the battery as soon as possible;
- In the case of AC connection, the DC input port is prohibited from linking to any equipment such as batteries.
- In power mode while operating, it is forbidden to connect to the battery.

1. Do not modify or disassemble the charger
2. Do not place the charger or battery near flammable objects during use. Do not charge or discharge on the carpet, paper, plastic products, vinyl, leather, wood, or charge or discharge inside the aircraft model or inside the car.
3. Do not place the charger within reach of children.
4. Do not drop wires or other conductive objects into the charger.
5. Ensure that the battery type and parameters are selected correctly. If you choose the wrong one, it may not only damage the battery, but it may also be dangerous (the lithium battery cannot be overcharged, it will cause a fire).
6. Do not mix batteries of different types, capacities, or manufacturers to use.
7. Do not attempt to charge a dry battery that cannot be recharged.
8. Do not charge or discharge if the battery leaks, swells, peels, changes in color, or deformed.
9. Do not exceed the maximum charge limit specified by the battery manufacturer.
10. Follow the instructions and safety advice of the charger manufacturer.
11. Please do not cover the fan outlet on the charger. Do not use it in direct sunlight, confined space or high temperature environment. In those cases, the temperature protection mechanism inside the charger may activate so that charging and discharge cannot be performed normally.



ShenZhen HOTA Technology Co., LTD.



Add: 213/215 , Floor 2, Building 6, Monli Industrial Park,
You Song Road., Longhua District, Shenzhen, China



Tel: 0755-28180135



Website: www.hota-exp.com



E-mail: info@hota-exp.com